

SALONE 2023 BATHROOM COLLECTION PREVIEW

We revealed the stunning **MA** Collection by **Foster+Partners**, which offers a contemporary approach to bathroom design. We also highlighted **Victor Vasilev**'s innovations in the **Eccentrico** and **Minimum** collections. All the new collections explore texture through the unique palette of **Falper** materials. Together, we celebrated the beauty of **design** and the bonds that unite us.

falper.

INDEX

Foster + Partners	04
MA island	06
MA wall	22
Victor Vasilev	56
Eccentrico	58
Minimum	70

Foster + Partners

Falper presenta in anteprima mondiale la collaborazione con lo studio londinese Foster+ Partners. Nasce una straordinaria collezione di arredi per il bagno, uno sguardo in avanti per promuovere bellezza e qualità e per essere l'occasione di riflettere sulle proposte nei nuovi spazi domestici.

Falper presents the exclusive preview of a collaboration with the London studio Foster+ Partners. An extraordinary collection of bathroom furnishings, the collection is a forward-looking archetype of beauty and quality and an opportunity to contemplate ideas for new kinds of living spaces.

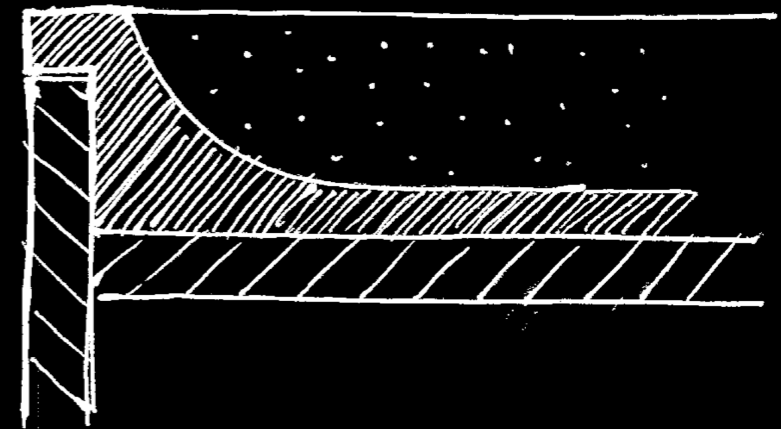

MA

Con MA nasce una collezione unica che si distingue per l'uso di tecnologie innovative, pur riprendendo lavorazioni artigianali e dettagli di ebanisteria. La versione freestanding presenta linee pulite e forme sinuose che conferiscono un senso di leggerezza all'ambiente. I materiali selezionati garantiscono la durata nel tempo, la resistenza all'umidità e la facilità di pulizia. L'illuminazione a LED può essere incorporata negli specchi e nei cassetti, creando un'atmosfera rilassante attraverso la luce soffusa.

MA is a unique new collection that distinctively combines innovative technologies with hand-craftsmanship and woodworking details. The freestanding version features clean lines and sinuous shapes that lend a sense of lightness to the space. The materials used guarantee durability, resistance to humidity and easy cleaning. LED lighting can be incorporated into mirrors and drawers, creating a relaxing atmosphere with soft light.







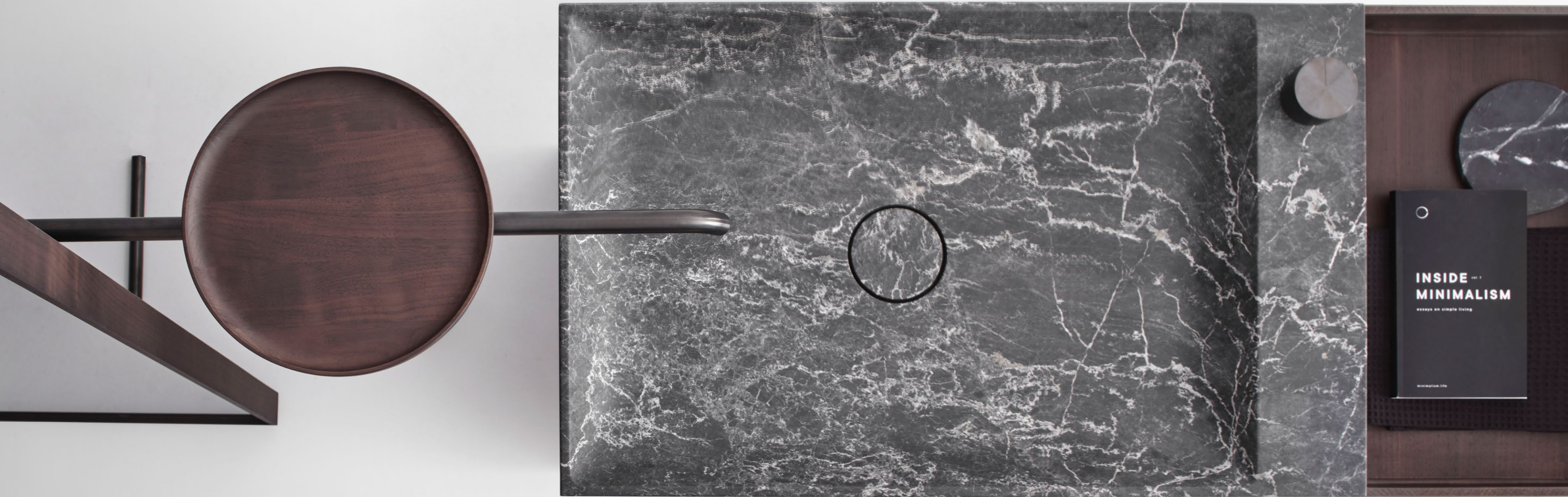

I cassetti integrati offrono ampio spazio per mantenere l'ordine nel bagno, consentendo di riporre asciugamani, prodotti per la cura del corpo e altri accessori essenziali.

Built-in drawers offer ample space to keep things tidy in the bathroom, holding towels, personal care products and other essential items.





Distillando l'essenza di un bagno al minimo, il sistema MA di Foster+ Partners crea un quadro architettonico flessibile su cui possono essere aggiunti diversi elementi, riconfigurati per soddisfare una miriade di spazi abitativi.

Distilling the very essence of a bathroom, the MA system by Foster+ Partners creates a flexible architectural framework to which various elements can be added and reconfigured to a myriad of living spaces.



**Base freestanding /
Freestanding base**

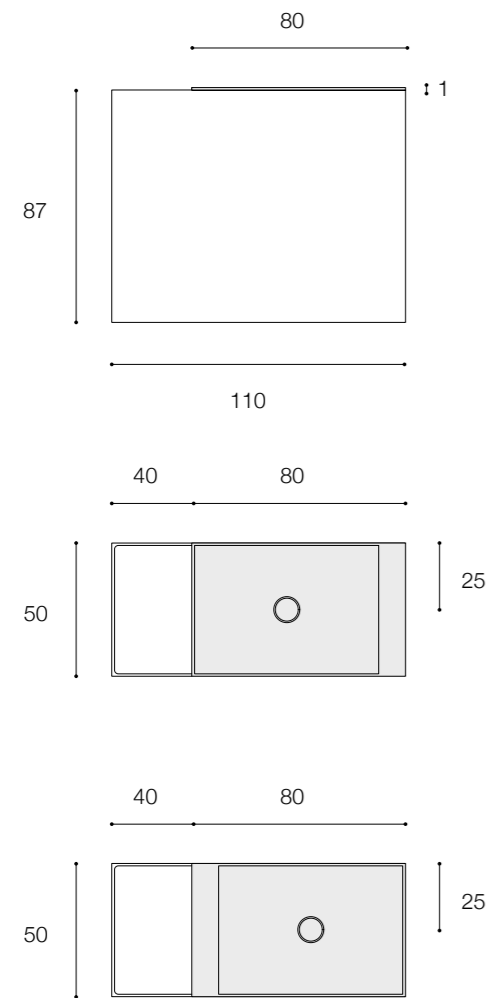

L'elemento a isola contiene quattro cassetti ed è realizzato nelle dimensioni di 110 x 50 x H 87cm. I comandi della rubinetteria possono essere posizionati sul piano del lavabo.

The island element contains four drawers and measures 110 x 50 x H 87cm. The valve controls can be positioned on the washbasin countertop.

**Bocca di erogazione da terra con mensola e specchio /
Wall mounted spout with shelf and mirror**

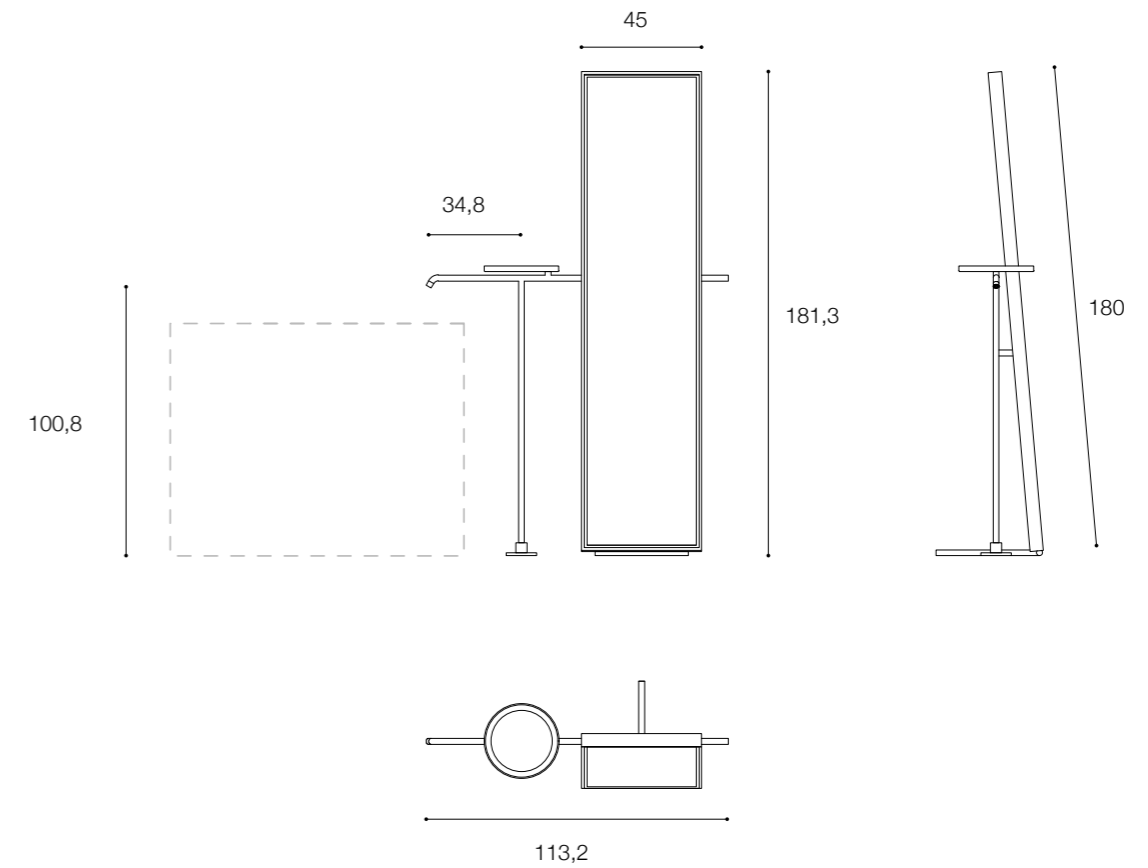

La bocca di erogazione con porta salviette e specchio è realizzata in acciaio AISI 316L in finitura spazzolata o PVD nero e può essere abbinata ai comandi della collezione Acquifero.

The spout with towel holder and mirror is AISI 316L stainless steel in a brushed finish or black PVD and can be combined with valve controls from the Acquifero collection.

MA

MA prende il nome dal concetto di “spazio-in mezzo”, caro all’arte e alla cultura giapponese, ponendo l’accento sul raggiungimento di un equilibrio armonioso tra gli elementi e lo spazio tra loro, in qualsiasi composizione artistica. Geometria volumetrica pura di vari elementi primari – lavabi, rubinetterie o specchi – interconnessi da sottili steli di erogazione dell’acqua, delicati ma funzionali.

MA: the name comes from the concept, central to Japanese art and culture, of “space in between,” emphasising the achievement of harmonious balance among elements and the space between them in any artistic composition. Pure volumetric geometry of various primary elements – washbasins, taps and mirrors – interconnected by slim, delicate yet functional water spouts.







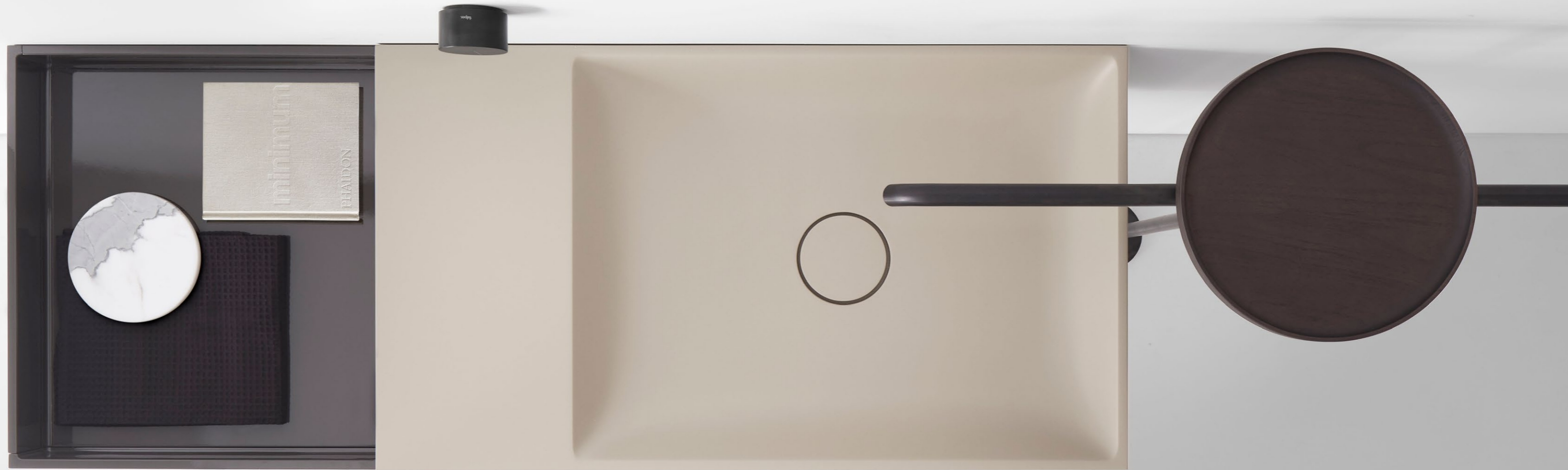

I piani di appoggio sono progettati come vassoi spaziosi. Il lavabo - 80cm di larghezza e 45 cm di profondità- può avere una vasca unica o un ripiano di appoggio laterale.

Counter tops are designed like roomy trays. The washbasin – 80 cm wide and 45 cm deep – comes in single basin form or with a lateral shelf.







La scelta dei materiali è molto ampia, con 10 finiture in marmo o Cristalplant® Bio Active colorato, in tutte le tinte disponibili del catalogo.

A wide range of materials to choose from, with 10 finishes in marble or coloured Cristalplant® Bio Active, in all available tones of the catalogue.





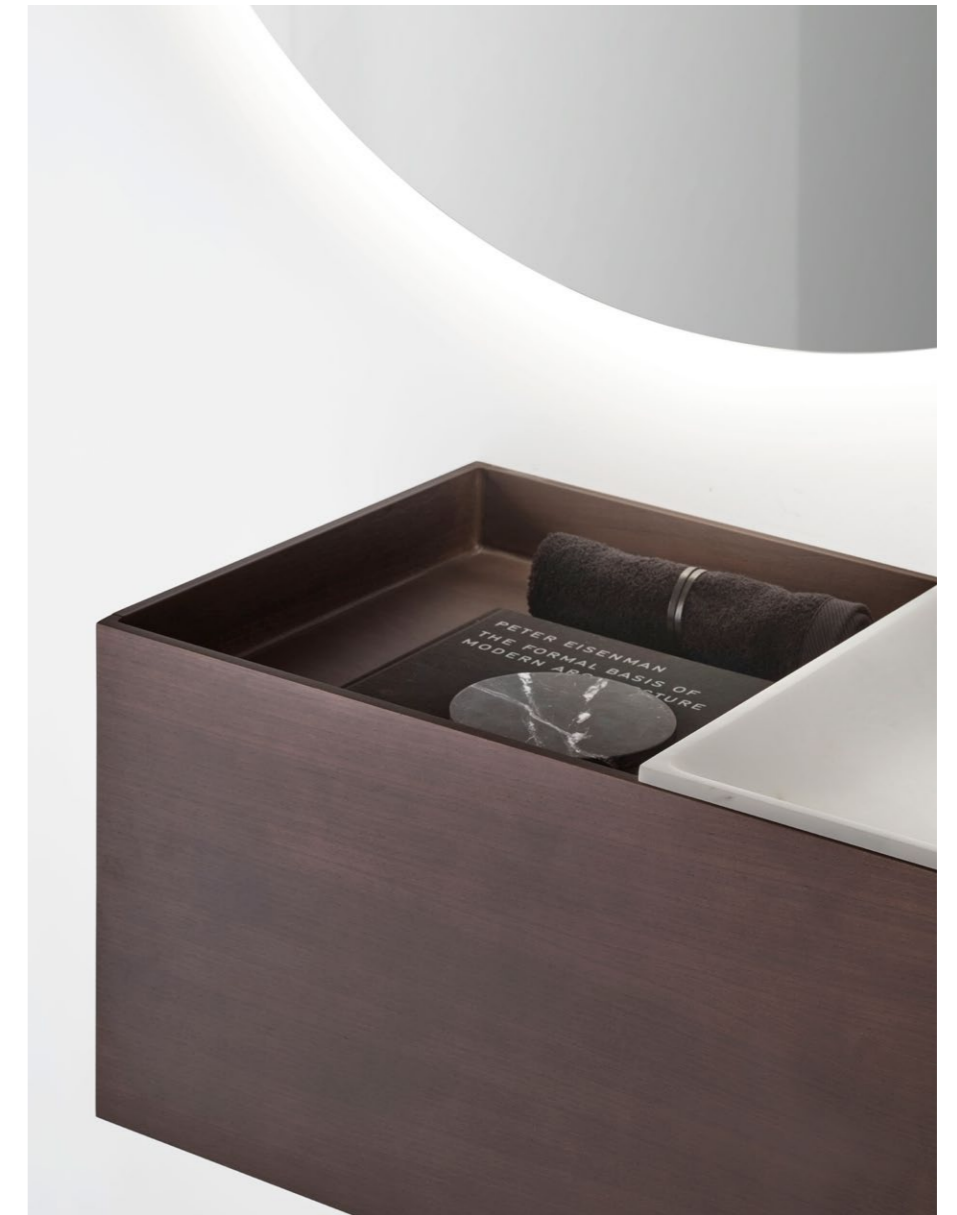

MA esplora la materialità, basata sulla tavolozza unica dei materiali Falper. I mobili possono essere realizzati in finiture legno con lavorazioni su legno massello ed in finitura laccata lucida o opaca.

MA explores the beauty of materials from Falper's unique palette. The cabinets are available in wood finishes with finely-crafted solid wood and in high-gloss or opaque lacquered finishes.



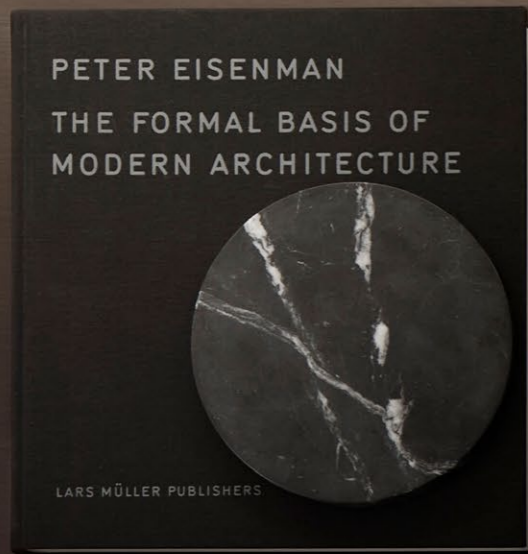

In questa immagine
il mobile da 160 cm
di larghezza in finitura
noce brown con lavabo
di marmo Jolie Grey.

In this image, 160-cm-
wide cabinet in walnut
brown finish with Jolie
Grey marble washbasin.



**Abaco dimensioni /
Abaco Set dimensions**

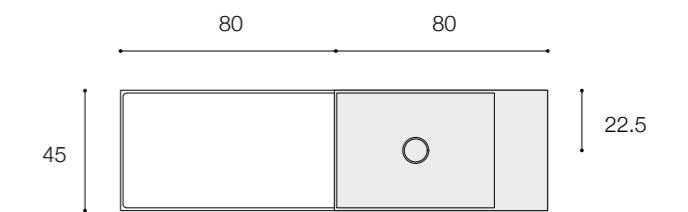
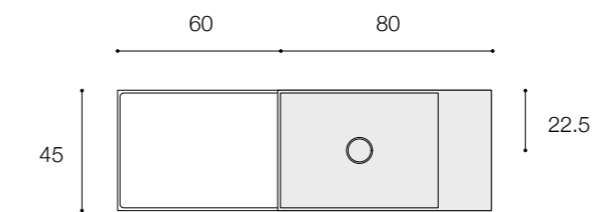
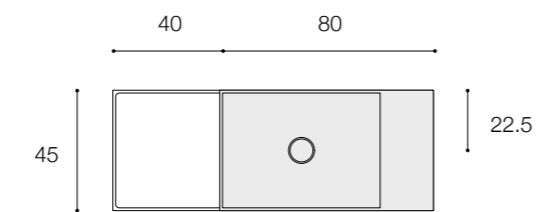
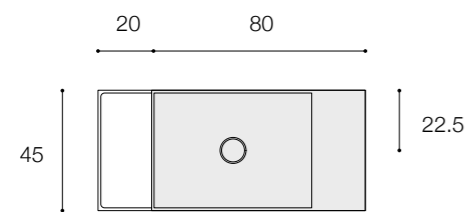
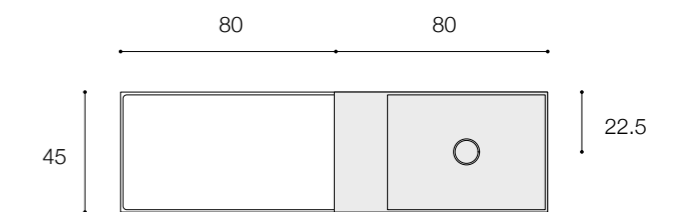
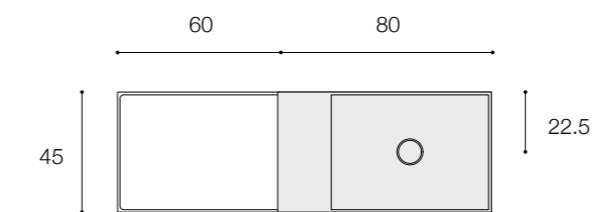
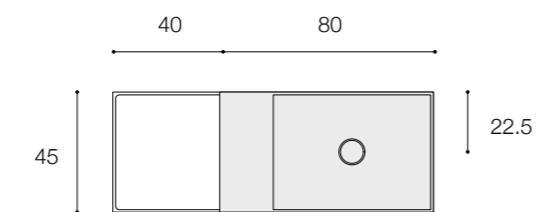
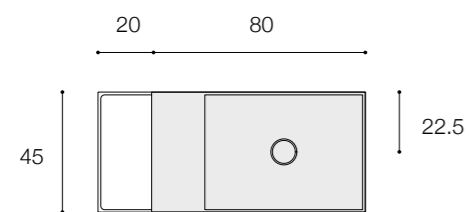
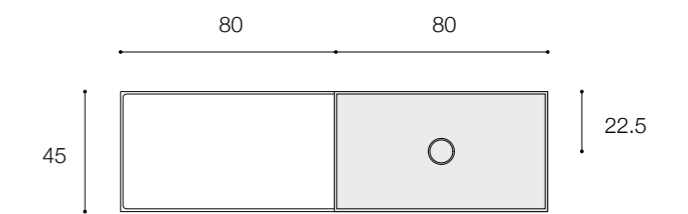
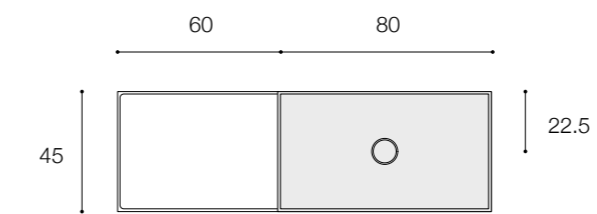
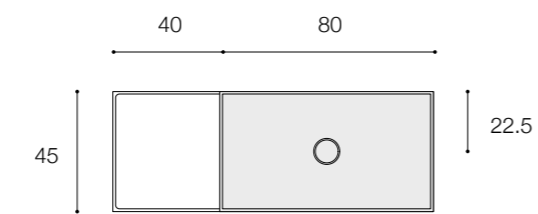
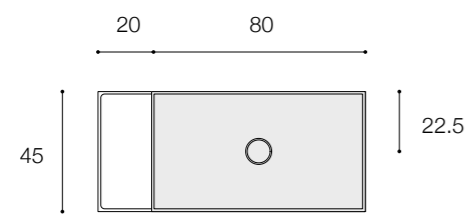
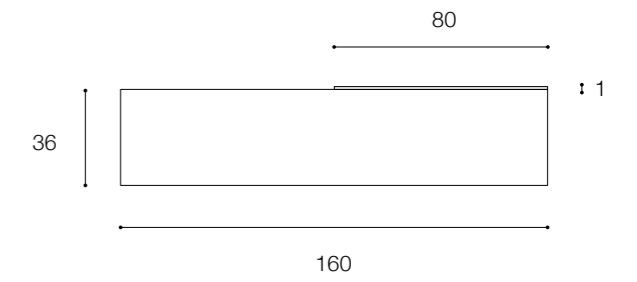
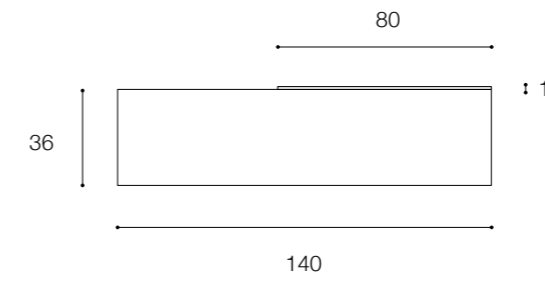
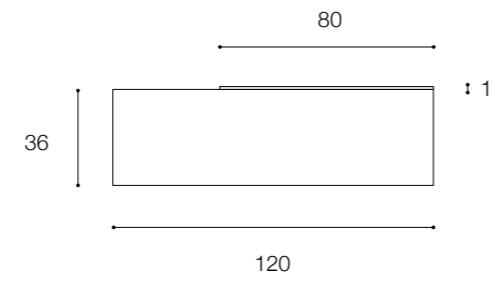
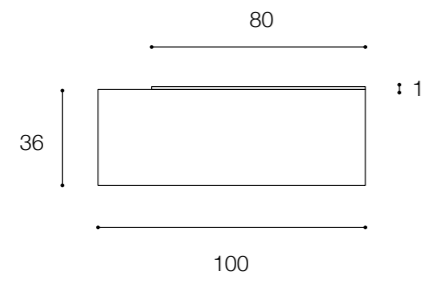

Ogni versione è disponibile destra e sinistra.
Each version is available left and right side.

Ogni versione è disponibile destra e sinistra.
Each version is available left and right side.

**Base componibile laterale /
Lateral modular unit**

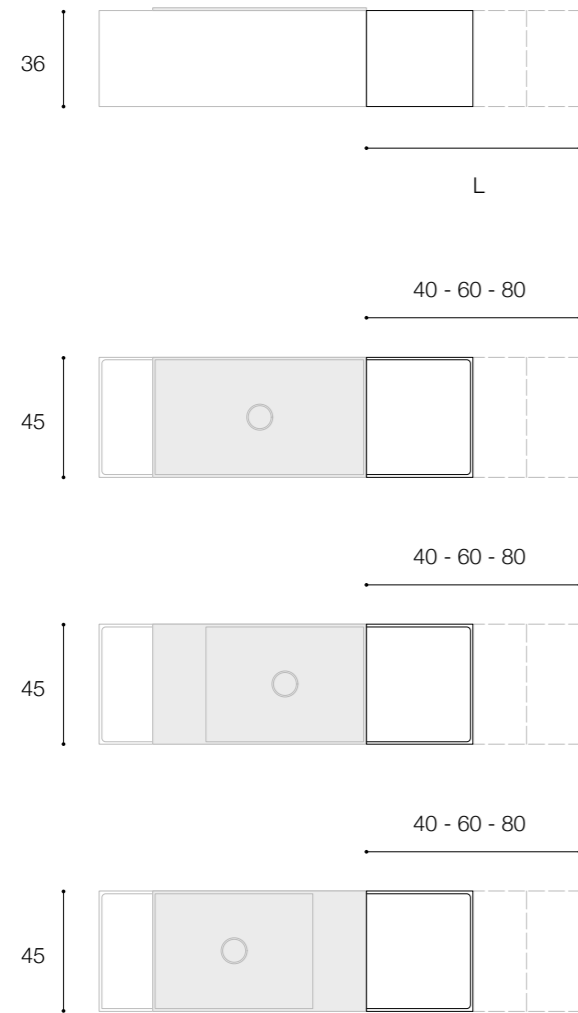

Ai mobili MA è possibile aggiungere una base laterale ad un cassetto, di larghezza 40, 60 e 80 cm.

MA cabinets can be enhanced with a one-drawer lateral base, 40, 60 or 80 cm wide.

**Bocca di erogazione da parete con mensola /
Wall mounted spout with shelf**

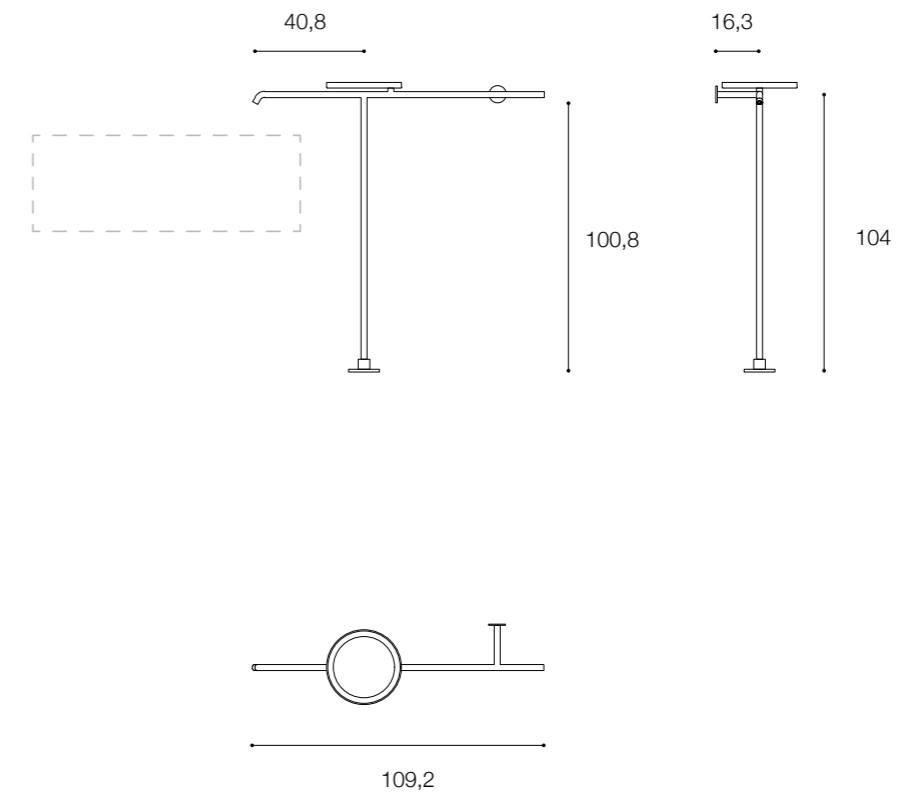

Le bocche di erogazione a parete sono realizzate in acciaio inox AISI 316L in finitura spazzolata o PVD nero e sono abbinabili ai comandi a parete e da piano della collezione Acquifero di Falper.

Wall-mounted spouts are in AISI 316L stainless steel, in a brushed finish or black PVD, with wall-mounted and countertop valve controls from Falper's Acquifero collection.

Lavabo / Washbasin

Marmi / Marbles

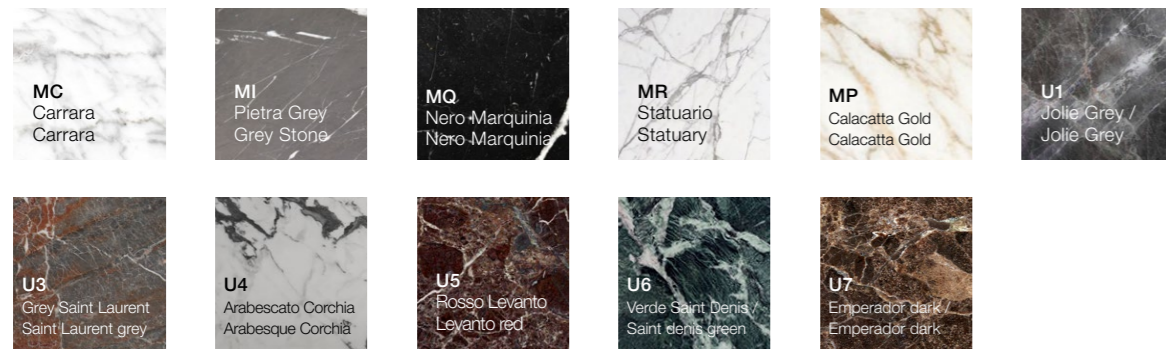

Cristalplant Bio Active



Mobile / Unit

Laccati opachi e lucidi / Matt and glossy painted - Cat. 1 / 3



Legni / Woods - Cat. 2

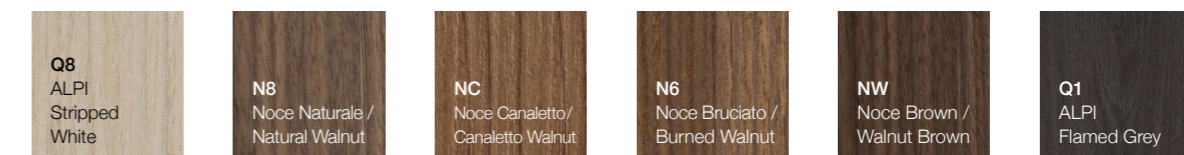

Victor Vasilev

VL'architetto Victor Vasilev basa il suo processo di ricerca nei progetti di design su alcuni punti di riferimento consolidati. Il suo stile, in apparenza rigoroso, cela un'ispirazione poetica, con la voglia di sperimentare e di sorprendere, anche se la geometria è la via maestra da seguire. Collabora con Falper dal 2018, ottenendo da allora diversi riconoscimenti internazionali.

Architect Victor Vasilev bases his design research process on a few consolidated touchstones. His apparently unembellished style conceals a poetic heart, and a desire to experiment and to surprise, although geometry remains his guiding concept. He has collaborated with Falper since 2018, receiving several international awards during these years.

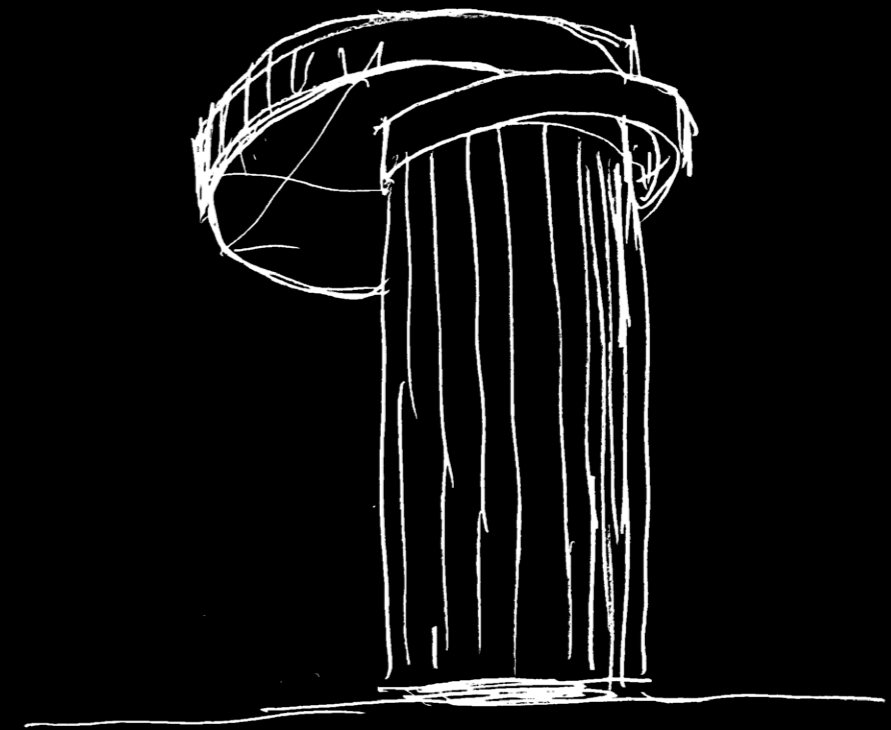

ECCENTRICO

L'evoluzione dell'iconica collezione Eccentrico si arricchisce della nuova lavorazione a doghe, realizzata su massello di legno. Questa ulteriore sofisticazione completa il lavabo freestanding, conferendo anche al cilindro di sostegno il carattere di eccellenza che contraddistingue l'intero progetto, sarà adottata anche sulle ante dei mobili porta lavabo.

The evolution of the iconic Eccentrico collection now features wooden slats enhancing solid wood. This further sophistication completes the free-standing washbasin, also giving the support cylinder the character of excellence that distinguishes the entire project, it will also be adopted on the doors of the washbasin cabinets.



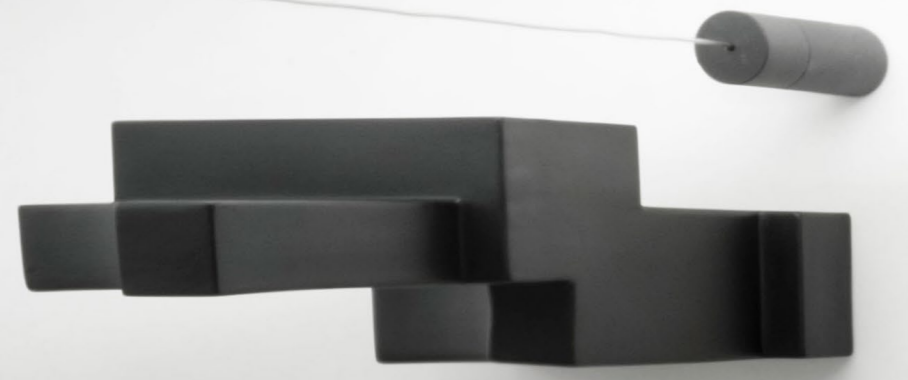

In questa immagine
lavabo in marmo
Rosso Levanto,
maniglione in
acciaio onice
e fusto in noce
naturale dogato.

In this image, a
washbasin in Rosso
Levanto marble, a
large handle in onyx
steel and a stem
in natural staved
walnut.



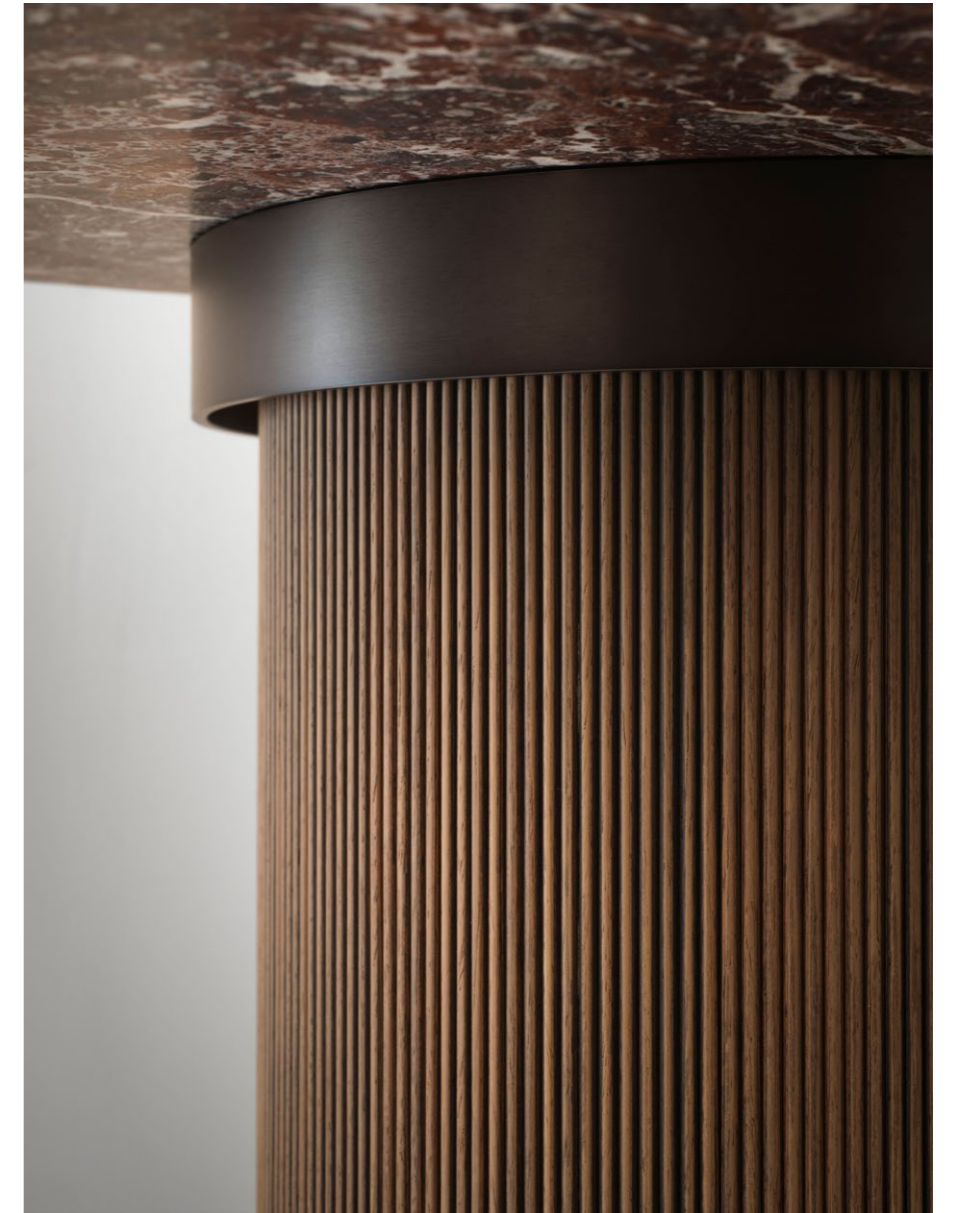

I lavabi sono disponibili in tutte le finiture Falper su base noce e rovere, in abbinamento ai metalli ed ai marmi che caratterizzano la collezione.

Washbasins are available in all Falper finished on walnut and oak bases, combined with the metals and marbles that distinguish the collection.

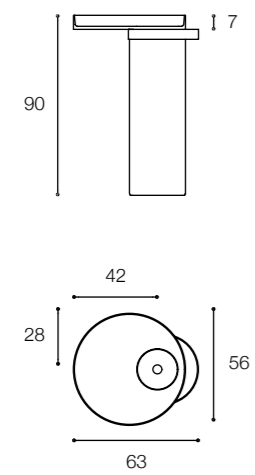

Lavabo / Washbasin

Marmi / Marbles

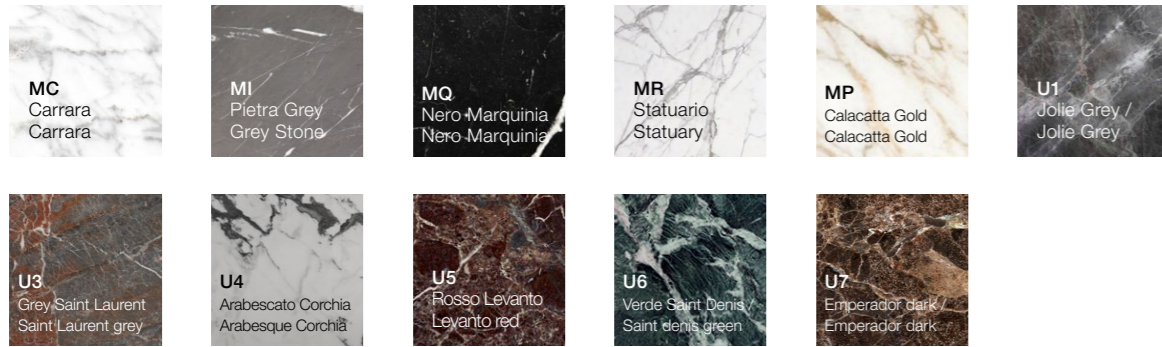

Cristalplant Bio Active



Mobile / Unit

Legni / Woods - Cat. 2

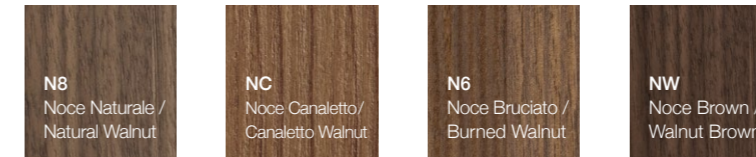

Porta salviette / Towel bar

Metalli / Metals

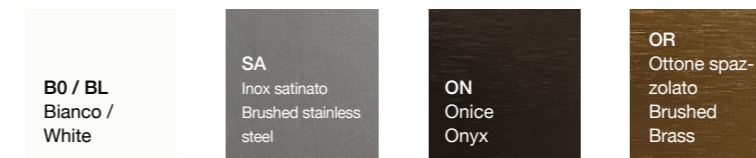

MINIMUM

Tra i best seller rivisitati, la collezione Minimum si completa di lavabi realizzati in Cristalplant Bio Active in varie altezze. Restano immutati la sua natura e il perfetto equilibrio dimensionale. L'evoluzione della collezione consente il posizionamento in soluzioni residenziali legate al contract e ai progetti dedicati all'hotellerie, riscuotendo importanti successi.

Among the revisited best sellers, the Minimum collection is completed with washbasins in Cristalplant Bio Active, available in various heights. The collection's original nature and perfect dimensional balance have been maintained. This evolution of the collection, which has been a great success, is also suited for contract residential and hotel spaces.









Accanto alla millenaria ceramica, il Solid Surface è un materiale innovativo facilmente pulibile, ripristinabile e riciclabile.

An alternative to classic ceramics, Solid Surface is an innovative, easy-to-clean, restorable and recyclable material.

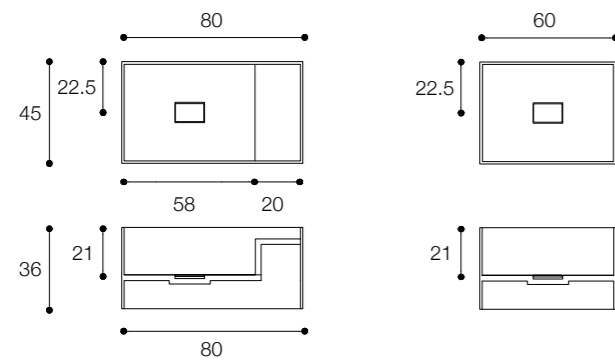



I lavabi della collezione Minimum sono realizzati in varie altezze in Solid Surface di origine bio, con proprietà antibatteriche, disponibili in tutte le finiture a catalogo.

The washbasins in the Minimum collection, in various heights, come in Solid Surface, a material of organic origin with antibacterial properties, available in all the finishes in the catalogue.

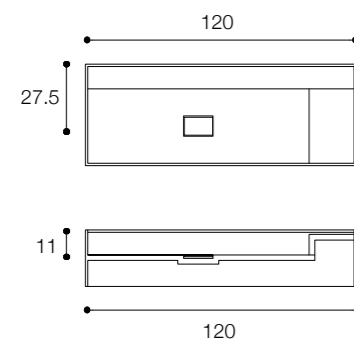

Lavabo / Washbasin

Cristalplant Bio Active



Mobile / Unit

Laccati opachi e lucidi / Matt and glossy painted - Cat. 1 / 3



Legni / Woods - Cat. 2

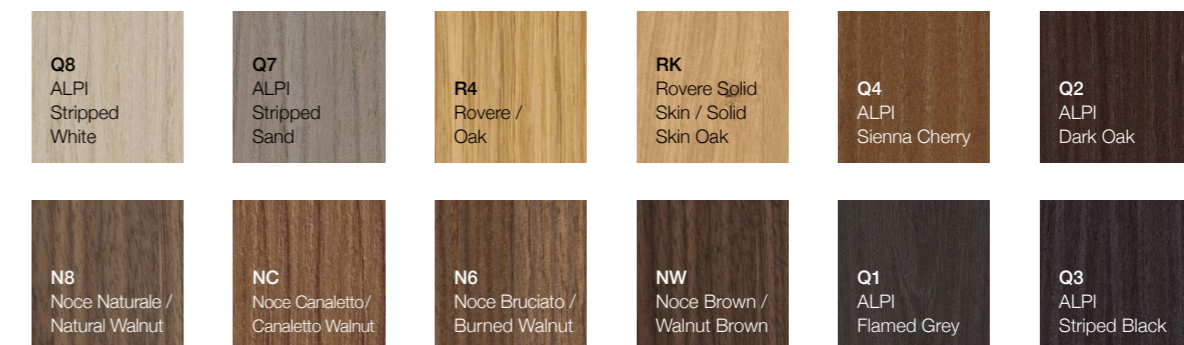

Credits

Graphic Design
Bianca Previato Schiesari

Photo
Alberto Strada
Giovanni Righetti

Styling
Bruno Tarsia Studio

Thanks to

oUmm
Mmairo
Upgroup
Fiammetta V
Scandola marmi
RAAK Design Studio
Carrara Home Design



Foster + **falper.**

MA è la linea di mobili per il bagno progettata da Foster + Partners che prende il nome dal concetto di "spazio-in-mezza", cioè un'area di transizione, promette l'accesso sul foglio in un modo di un equilibrio armonioso tra gli elementi lo spazio del bagno e il bagno stesso. Il bagno è un luogo di transizione, un luogo di incontro tra il bagno e il bagno. Il bagno è un luogo di transizione, un luogo di incontro tra il bagno e il bagno. Il bagno è un luogo di transizione, un luogo di incontro tra il bagno e il bagno.

ZARA

RaffinesViking

falper.

falper.

INTERNI
Salone 2023

HELBIZ

lime

Falper srl

Via Veneto 7 – 9
40064 Ozzano Emilia, Bologna (Italy)

Tel + 39 051 799319

Fax + 39 051 796495

info@falper.it – www.falper.it